



UNIVERSITÄTS-
BIBLIOTHEK
PADERBORN

**Vorlagen für den gewerblichen Fachunterricht an
technischen Lehranstalten insbesondere an
Gewerbeschulen**

Kircher, Philipp

Karlsruhe, [1886 - 1889]

VI. Schreinerarbeiten (Möbelschreinerei).

[urn:nbn:de:hbz:466:1-97992](https://nbn-resolving.org/urn:nbn:de:hbz:466:1-97992)

Aufgabe.

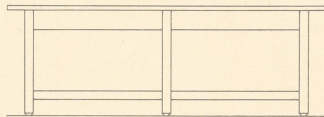

Tisch im Gesindezimmer für 10 Personen.
à Person 55-65 cm Länge.
Tischhöhe 75 cm. Tischbreite 90 cm.

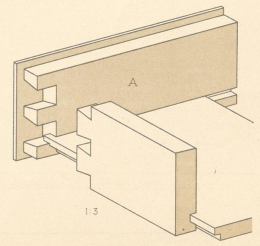
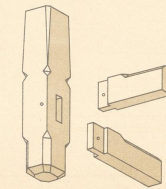
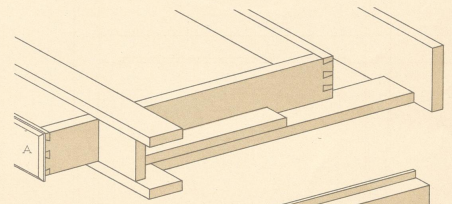
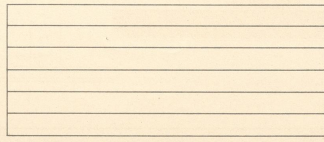
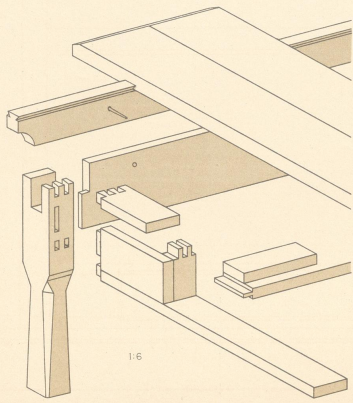

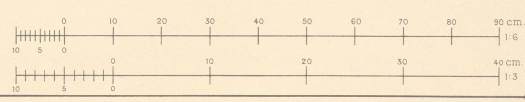
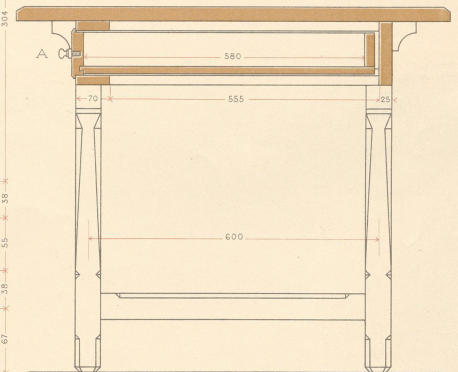
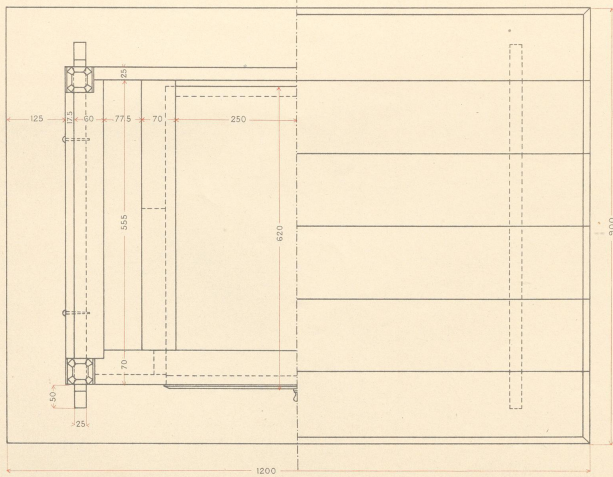
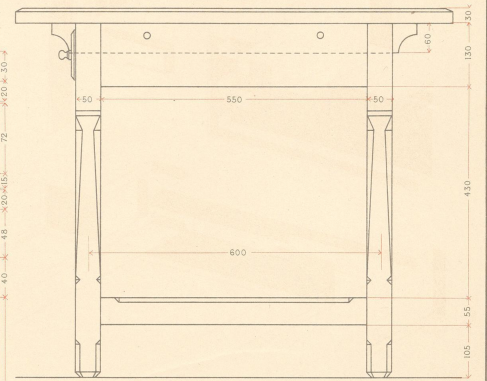
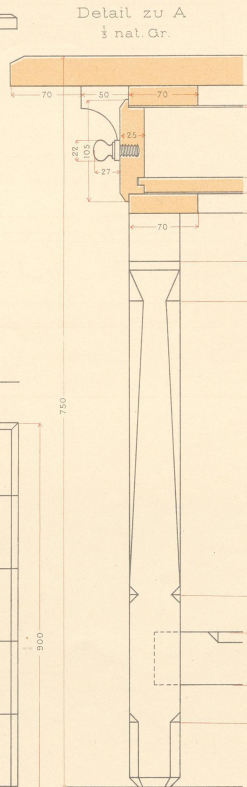
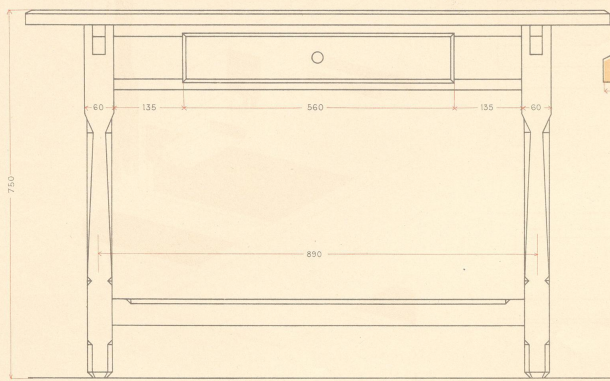

Wohnort und Datum.

Namen.

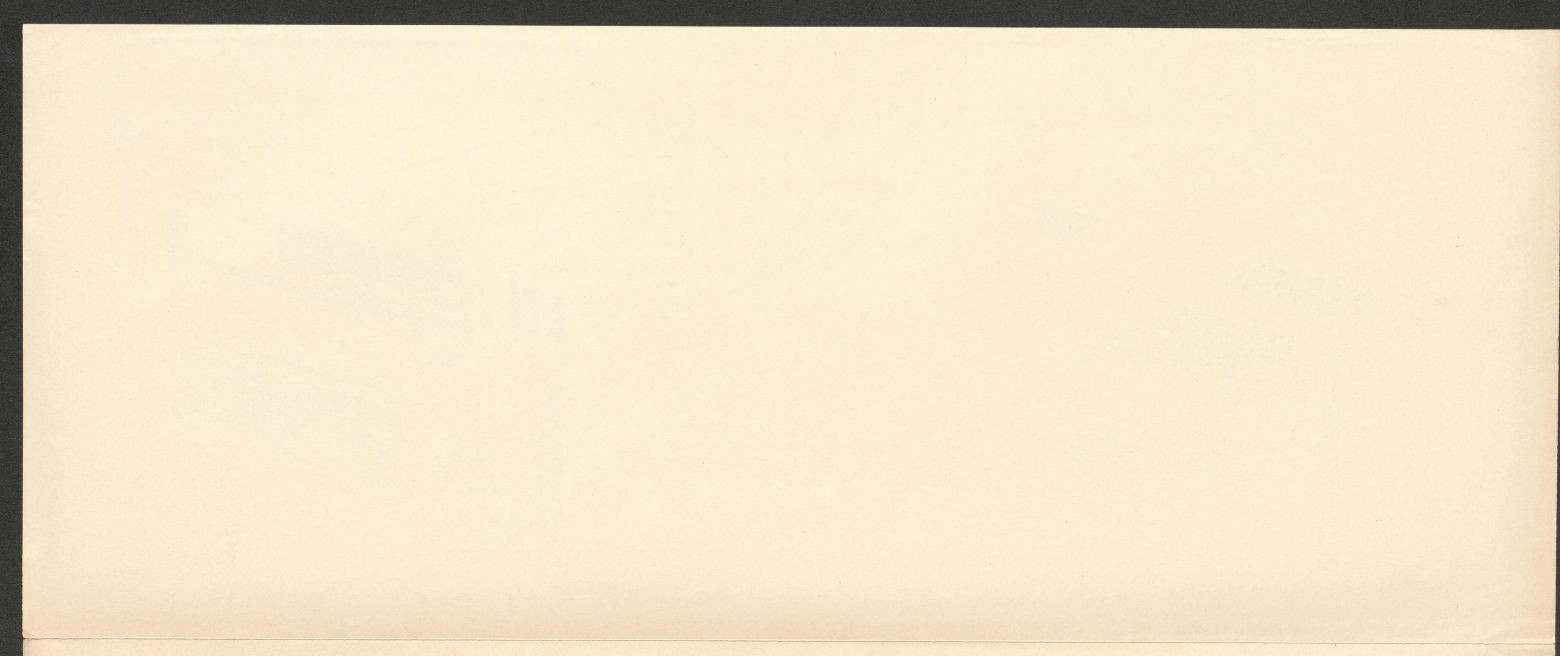

K 2/14
EK 938



D6
1076
/1999

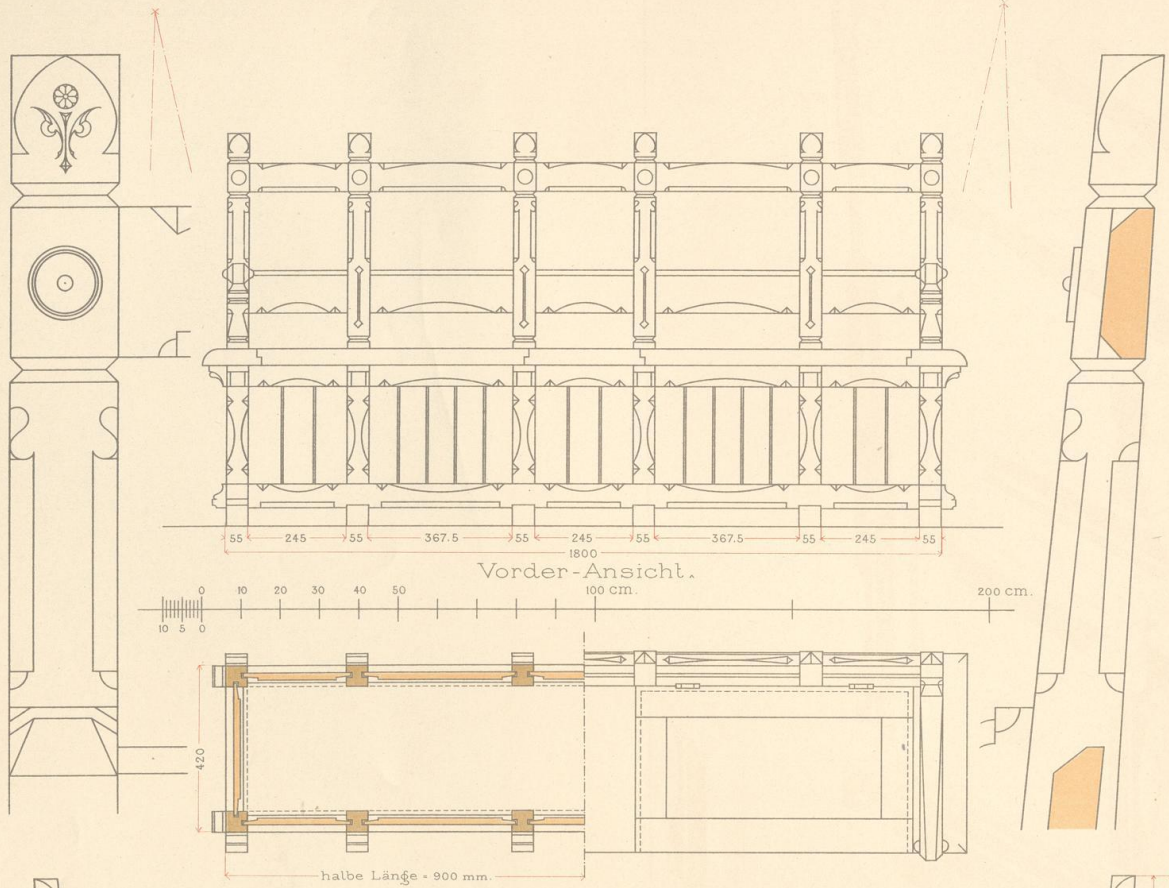

Grundriss des Kastens.

Ansicht von oben.

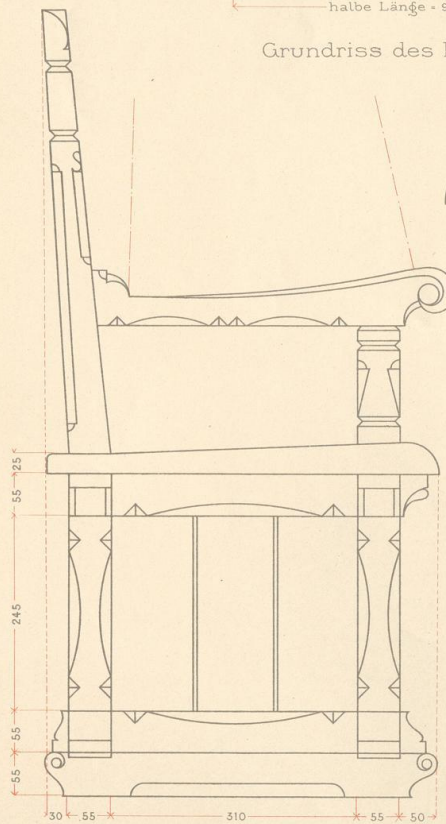

Seitenansicht.

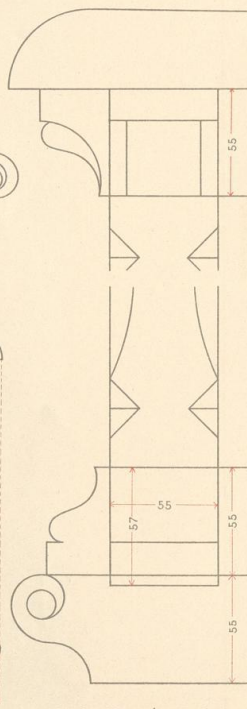

Details 1/2 n. Gr.

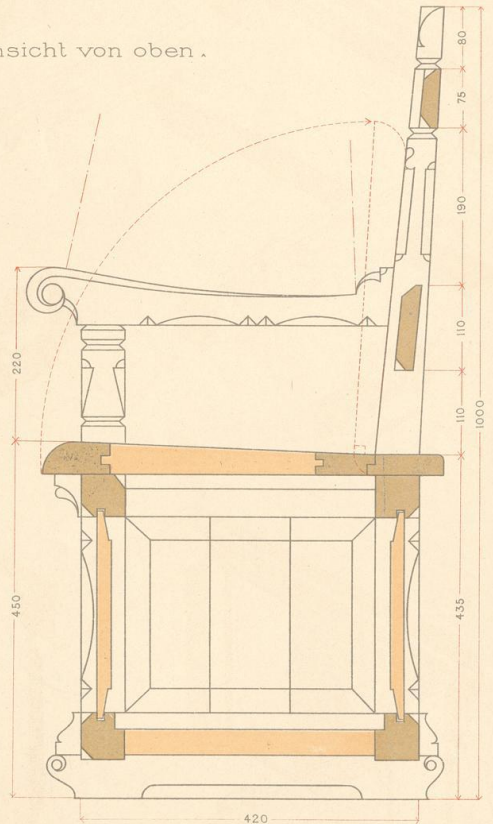

Querschnitt.

Wohnort und Datum.

Namen.



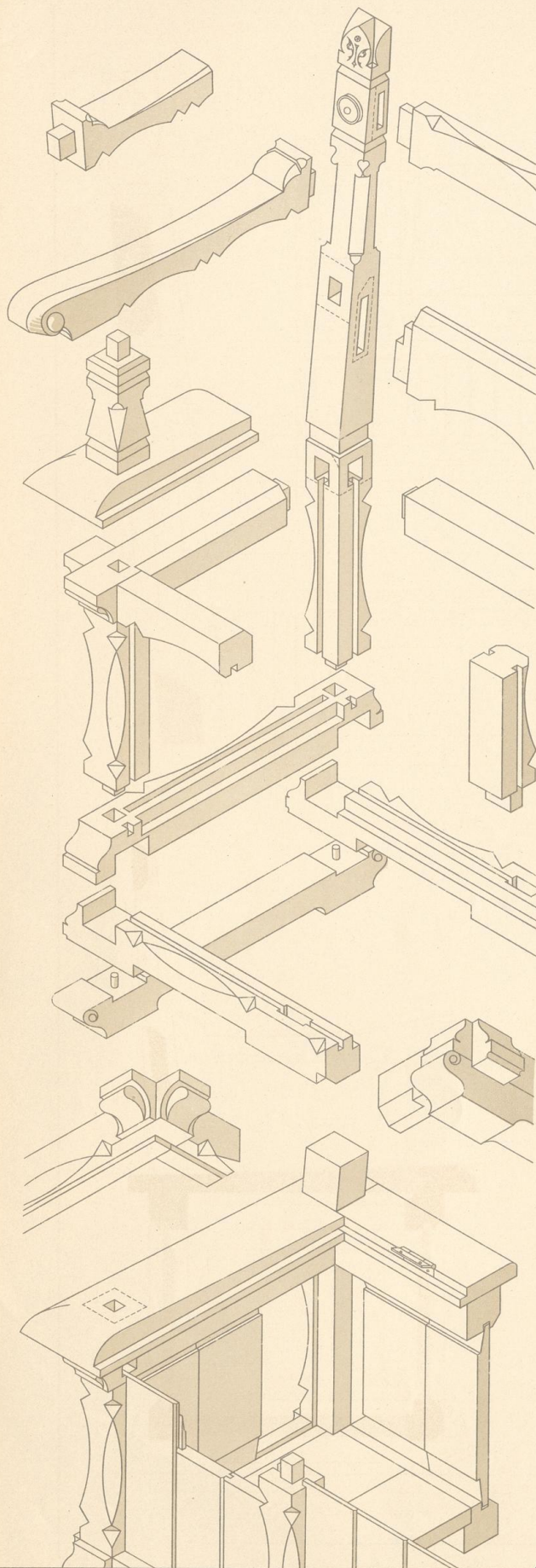



06
WTG
1199

EK 938
K D/XV

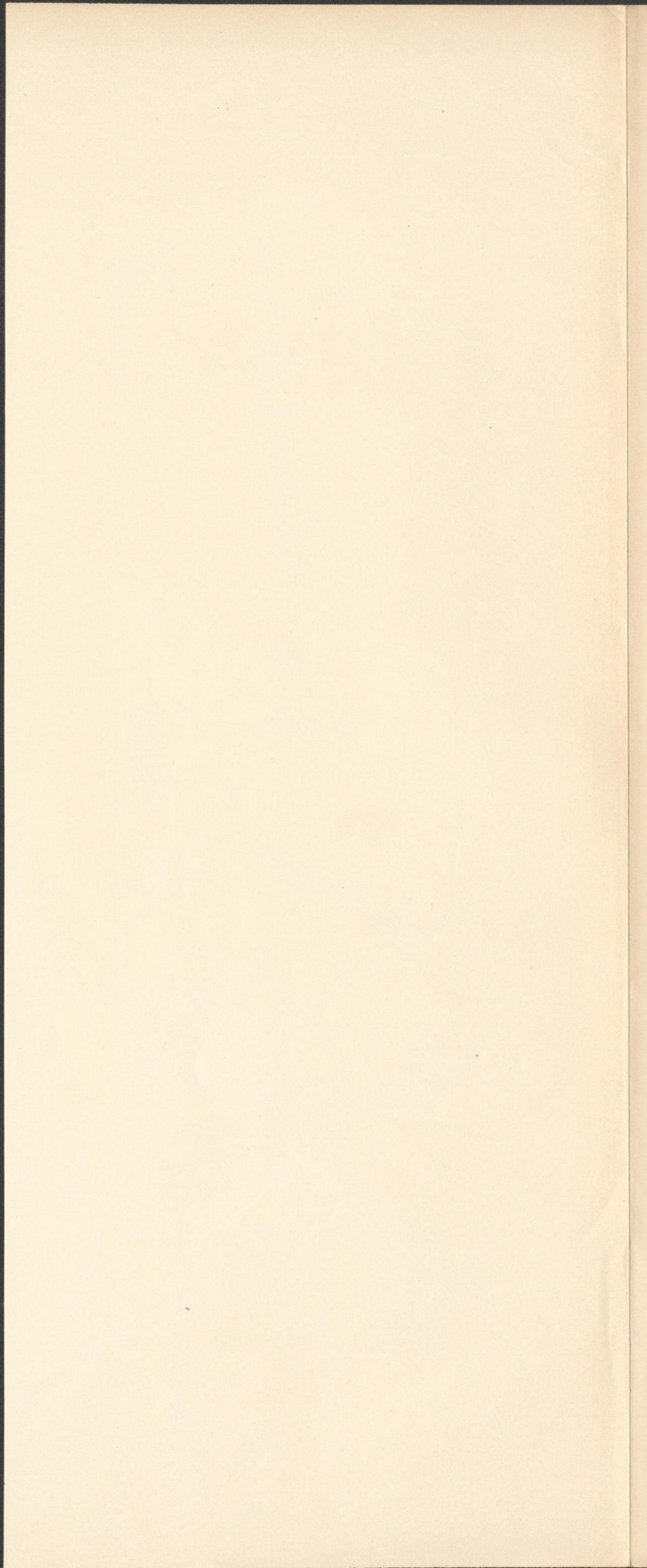

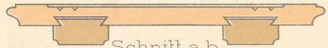
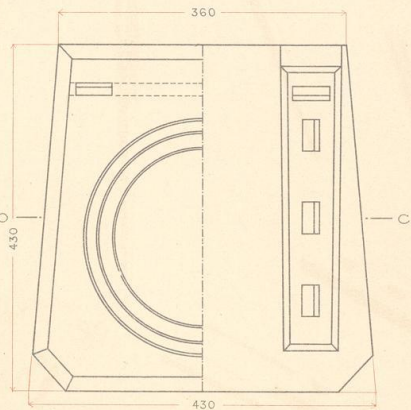
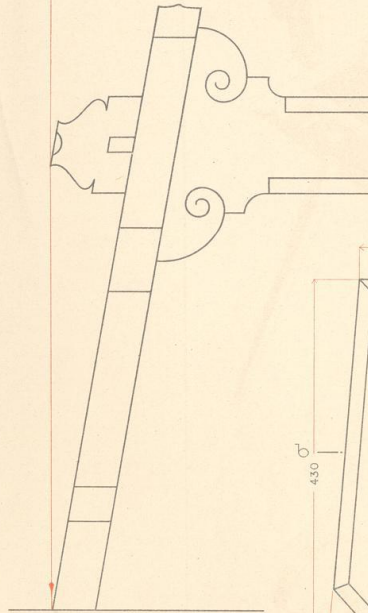
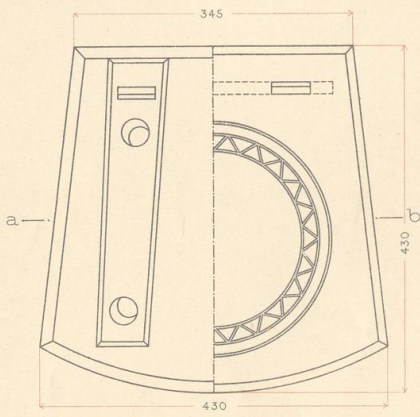
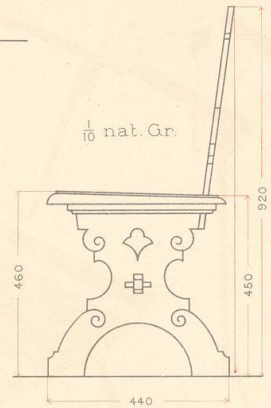
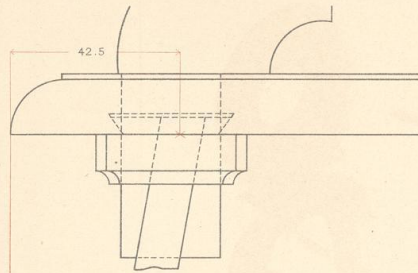
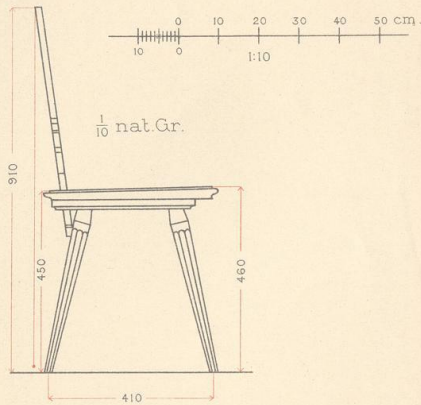

Details 1/2 nat. Gr.

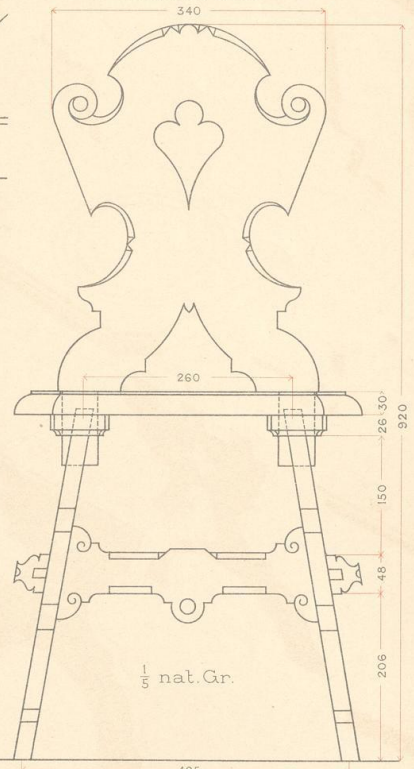
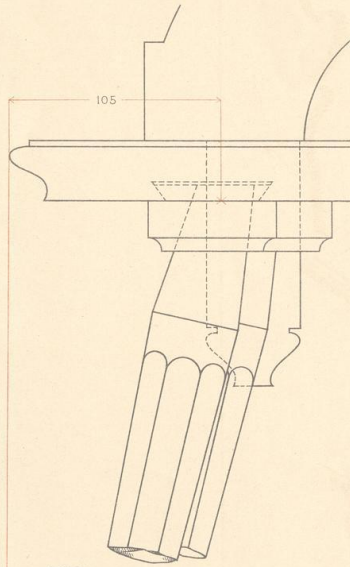
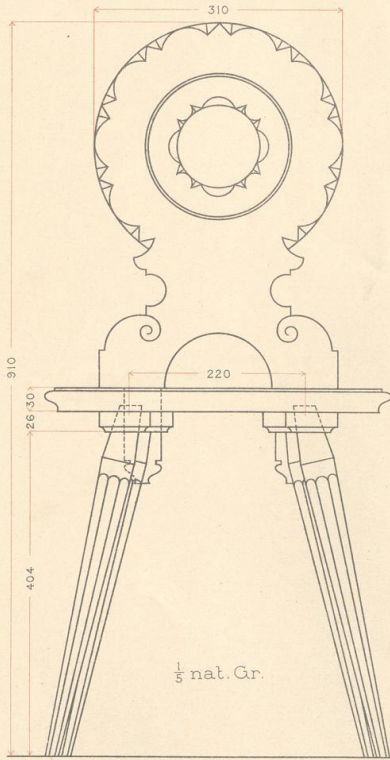
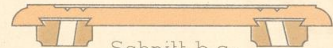

100 cm. 1:5

Wohnort und Datum.

Namen.

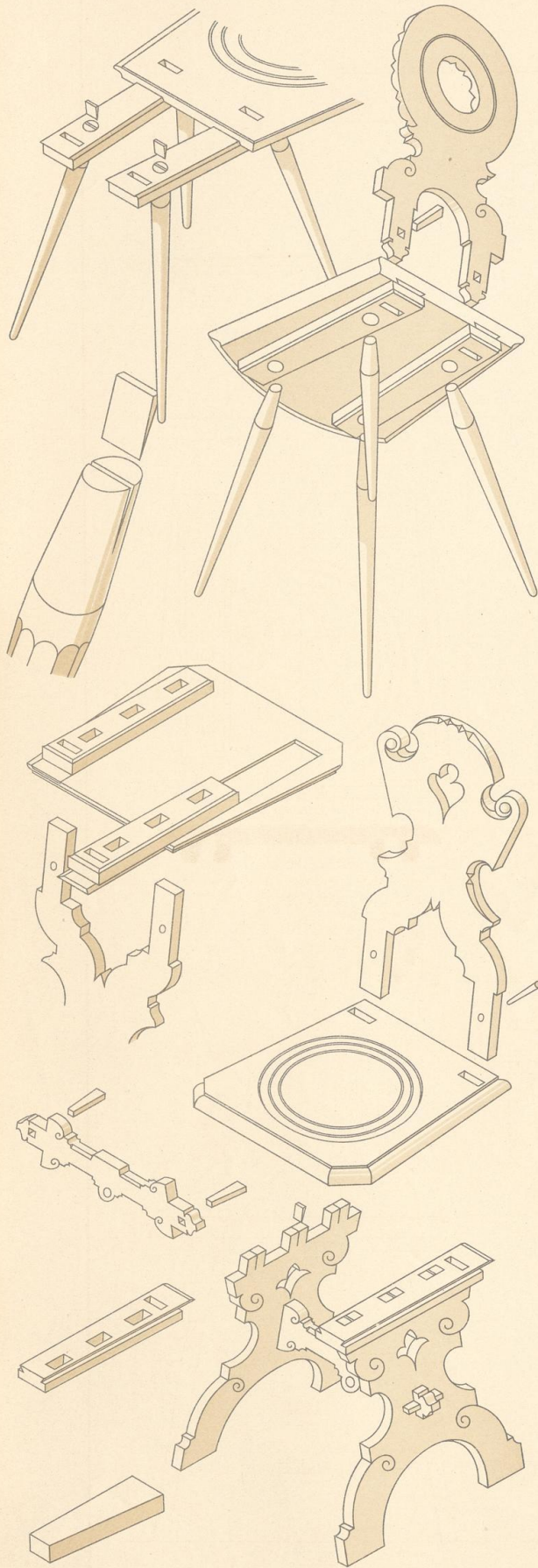



06
WTG
1199

EK938
K D/XV

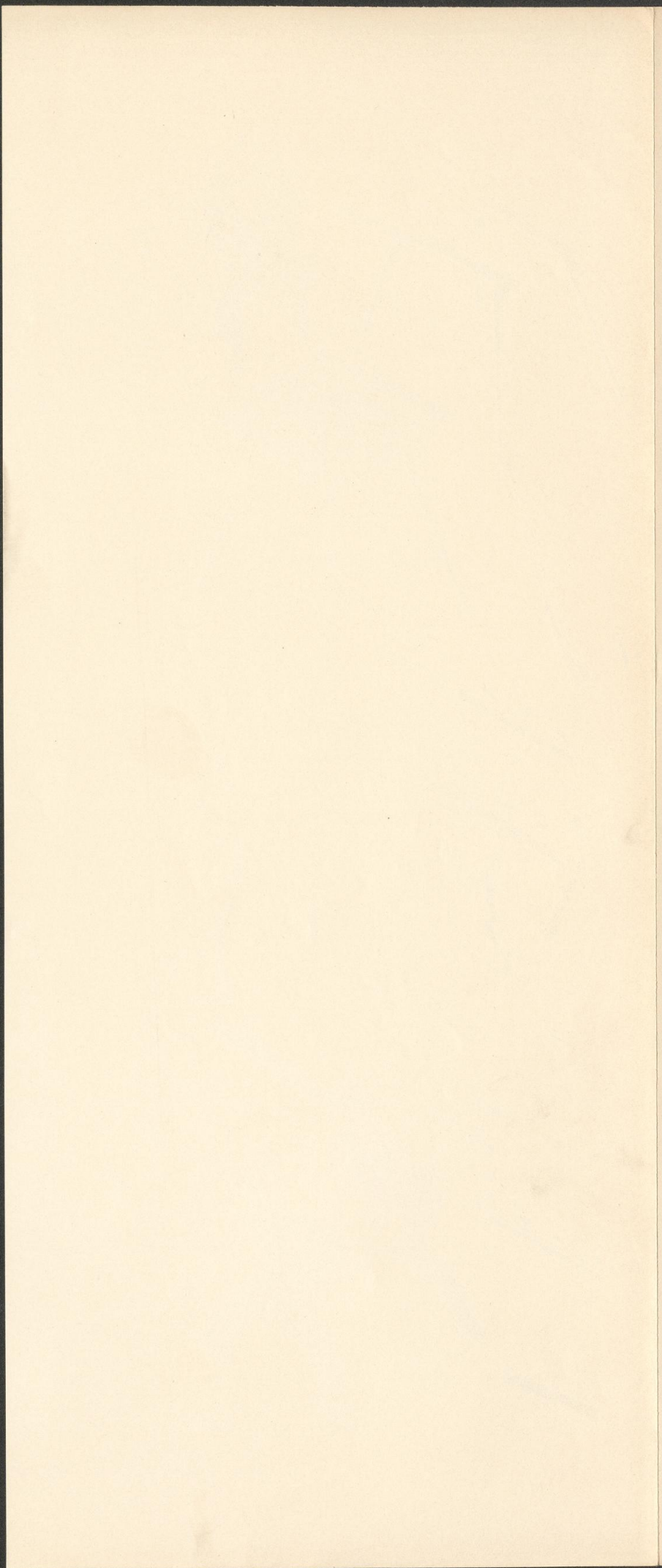

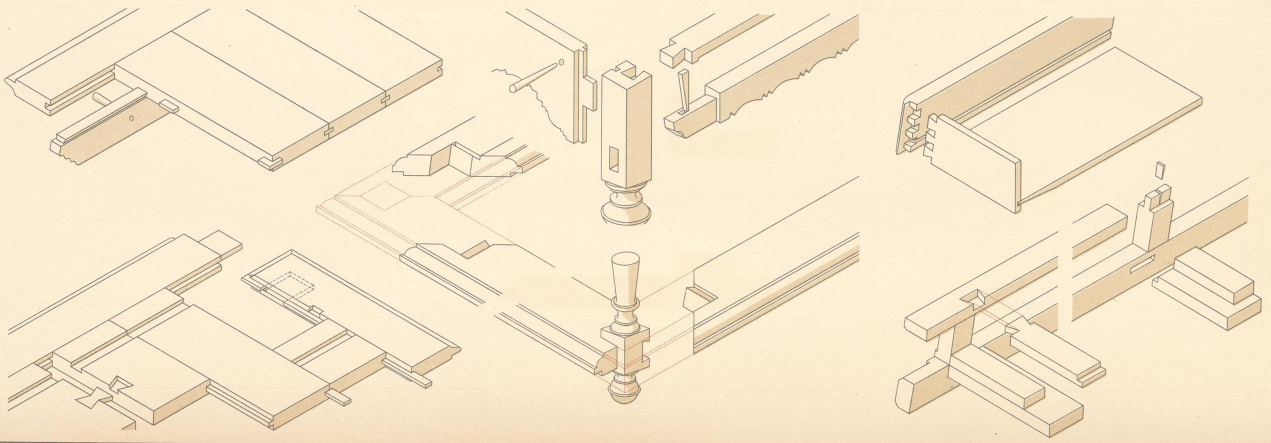

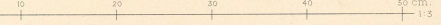
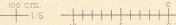
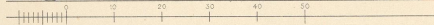
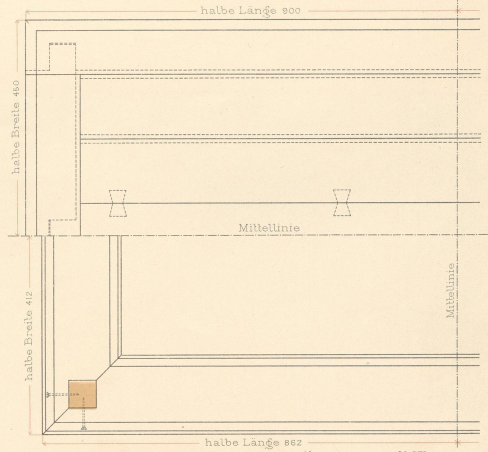
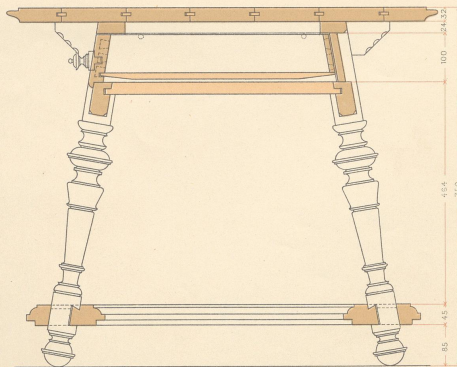
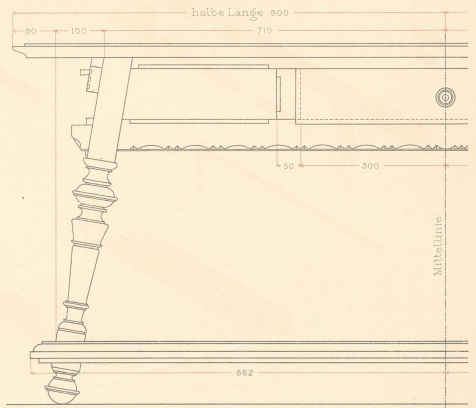
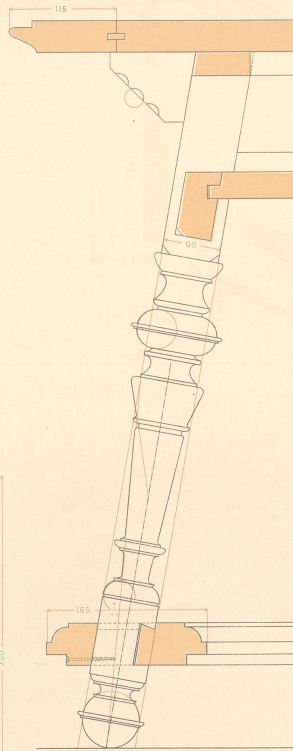
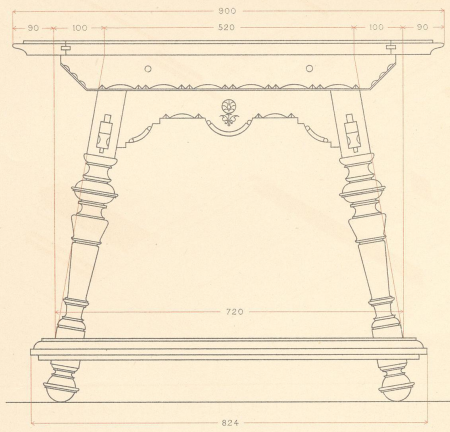

Wohnort und Datum.

Namen.

EK 438
K D/MV



06
JTG
M49

Unteres „Haupt“ u.
Längensicht.

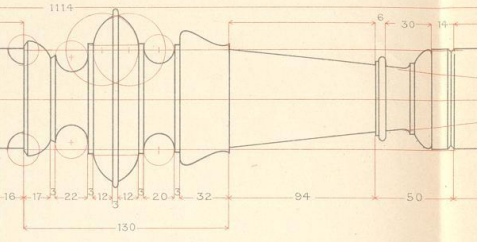
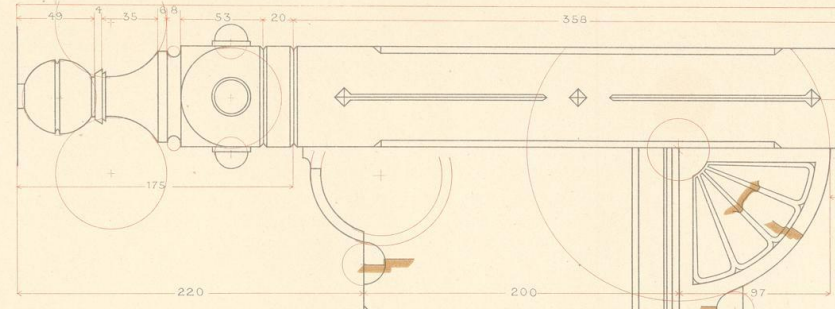

Längensicht.

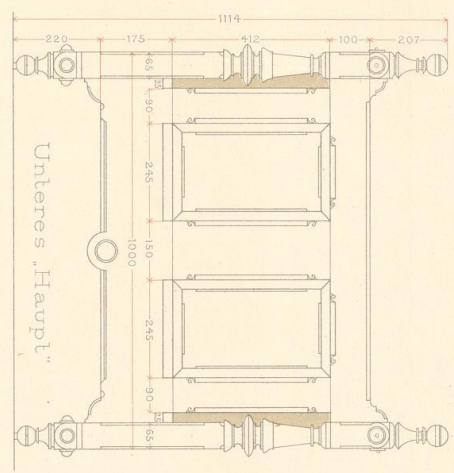
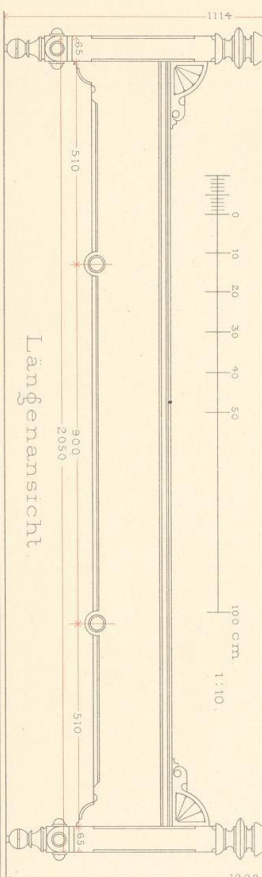

Unteres „Haupt“

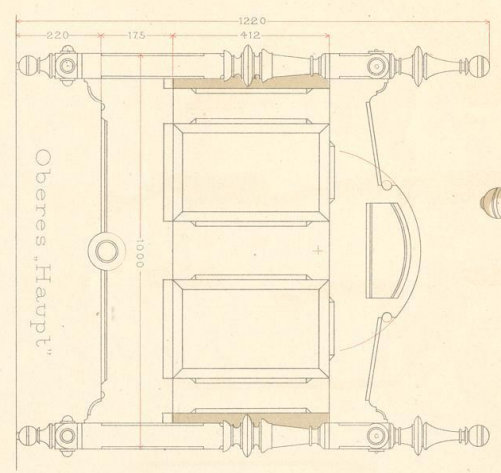

Oberes „Haupt“

Oberes „Haupt“

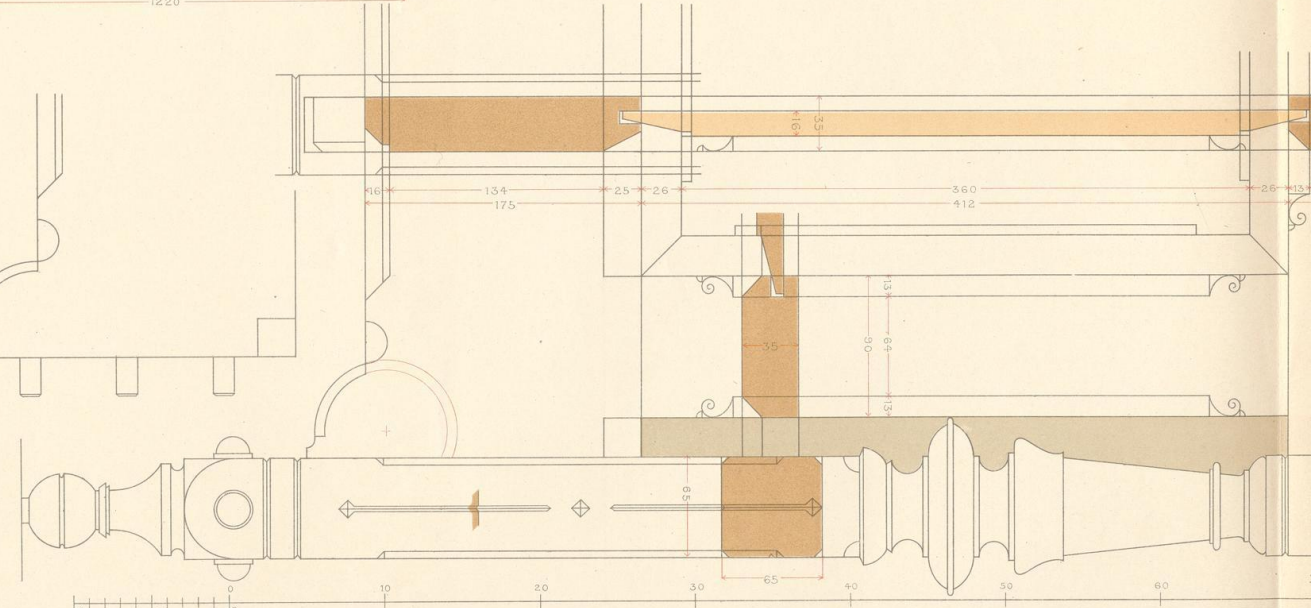

Wohnort und Datum.

Blatt VI 5.



Schreinerarbeiten.

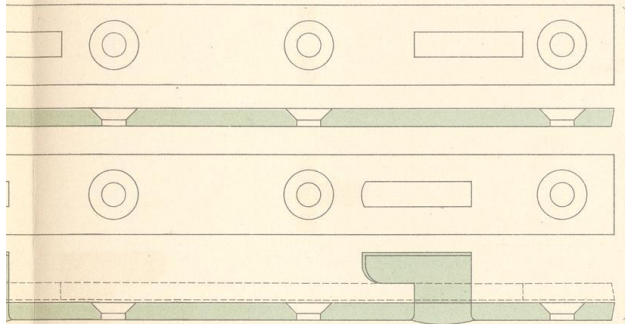
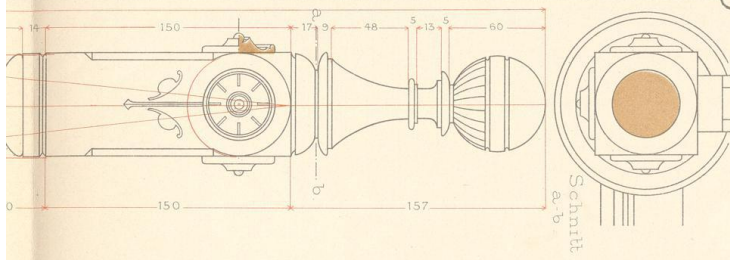

Beschläge
nat Gr.

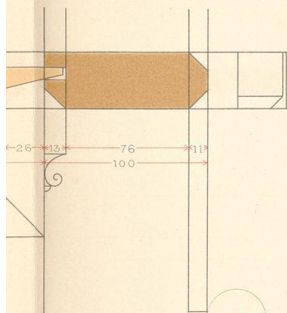
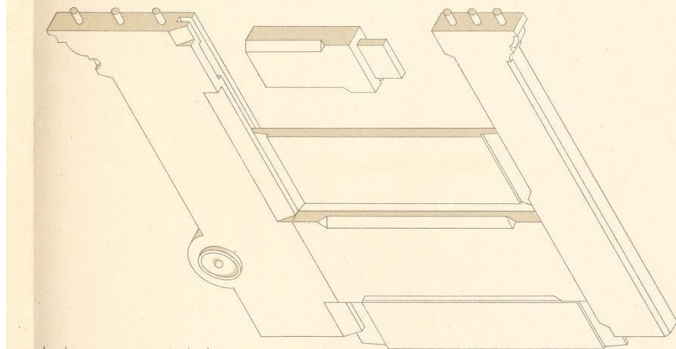
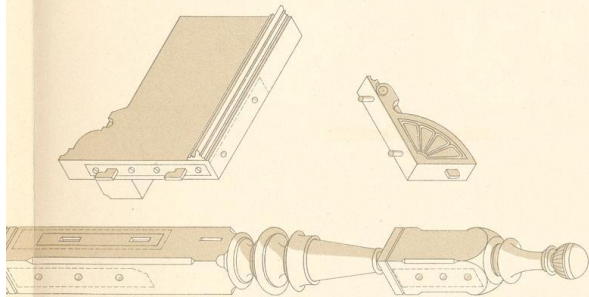

Dübelung der Freise.

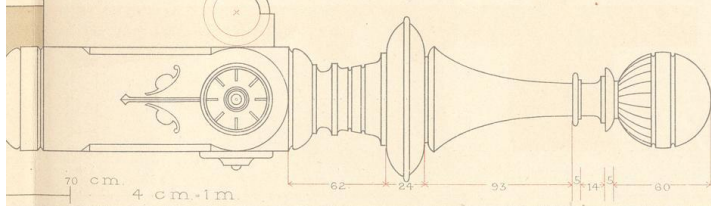
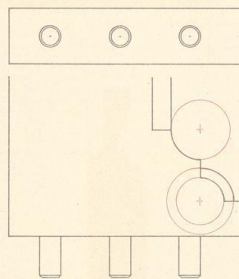

Namen.



06
WTG
1199

EK 938
K D/XV

Nachttisch.

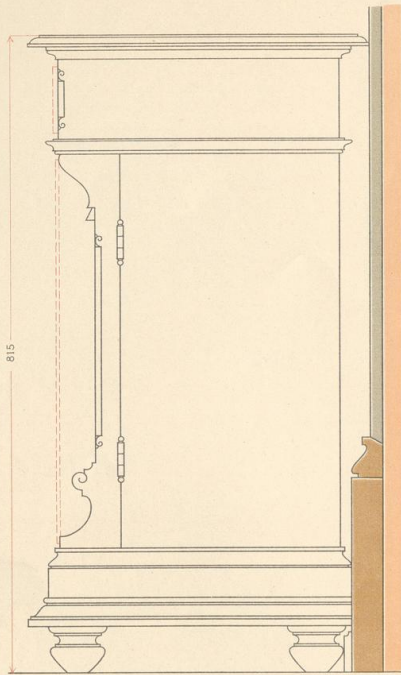

Seitenansicht. Variation.

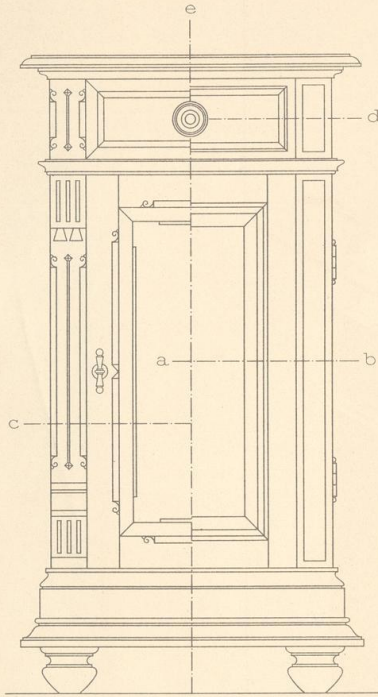

Vorderansicht.

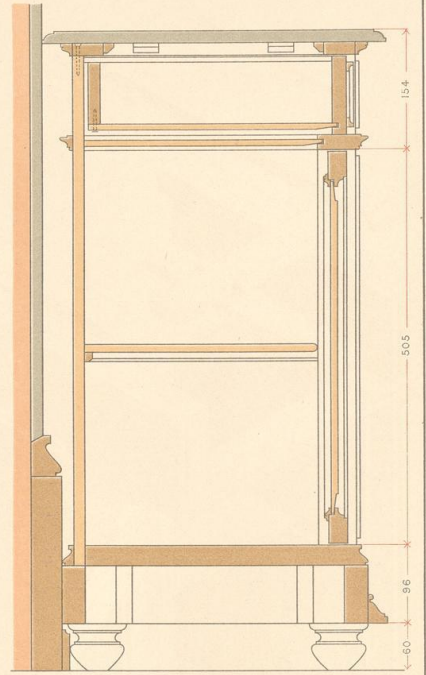

Schnitt e f.

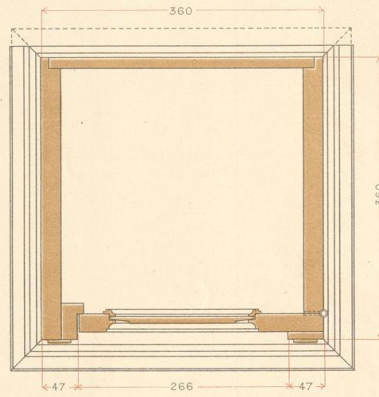
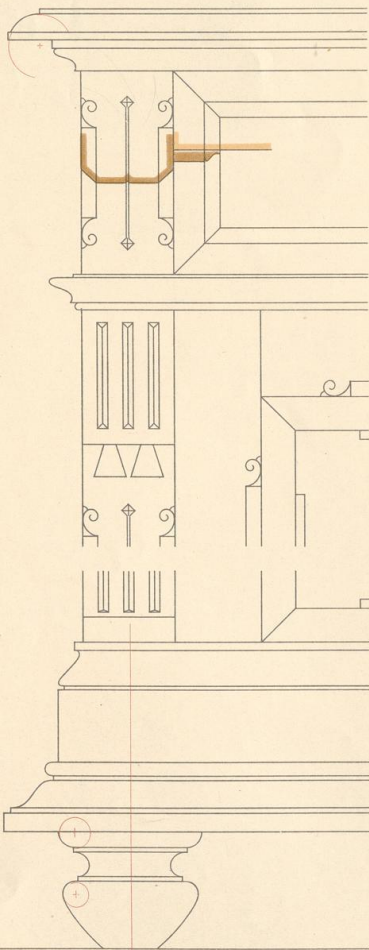

Schnitt a b.

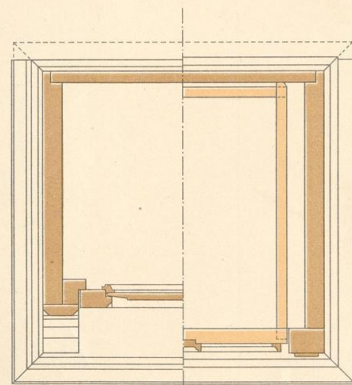

Schnitt c d.

Details 1/2 nat. Gr.

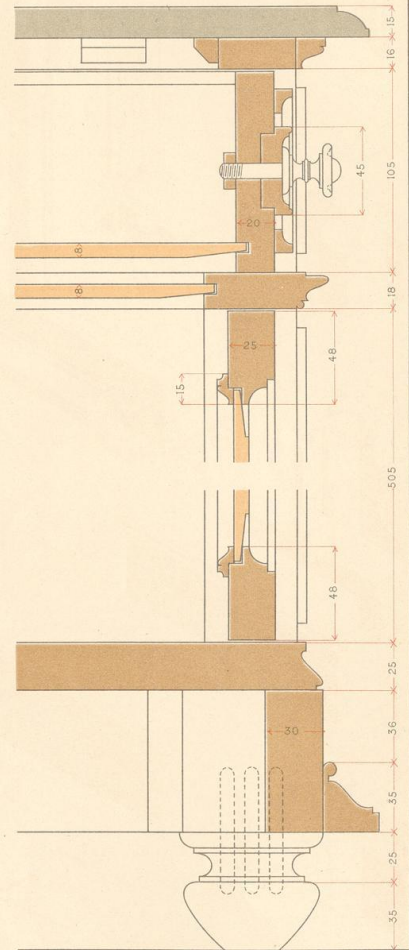

Wohnort und Datum.

Namen.

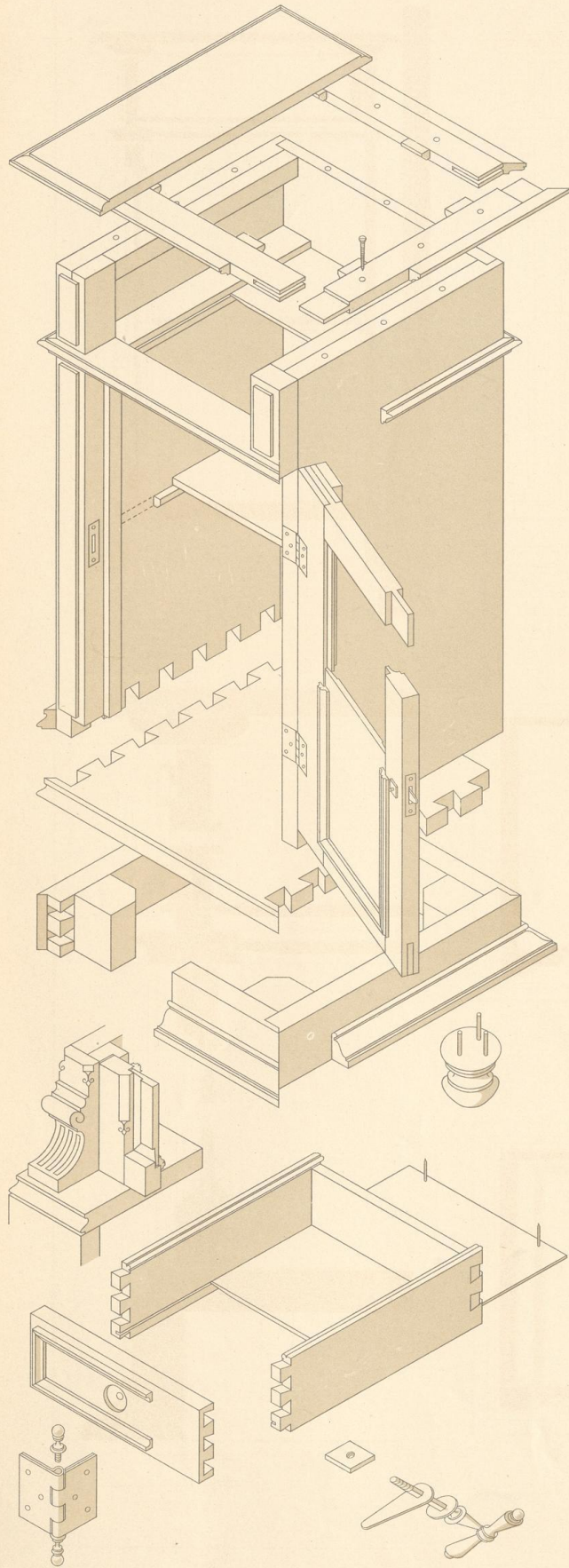



06
WTG
1199

EK 938
K D/XV

Waschkommode.

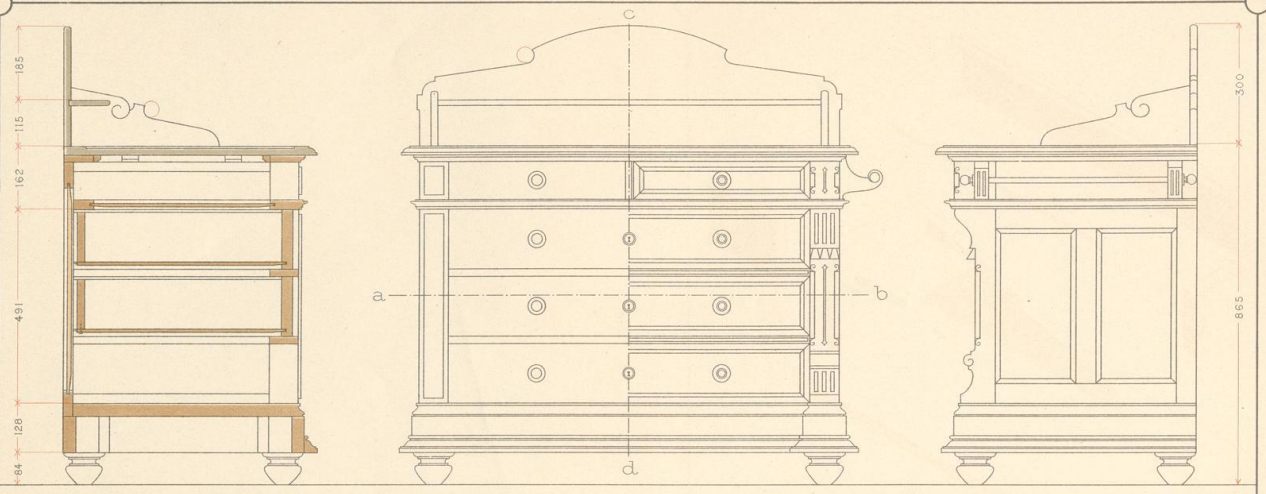

Schnitt c d.

Vorderansicht.

Seitenansicht, Variation.

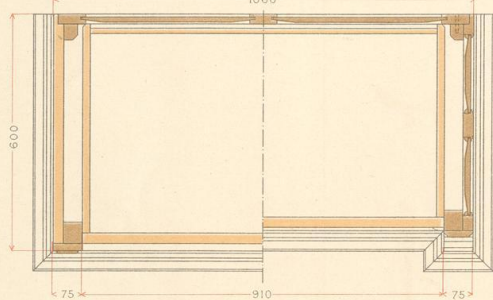
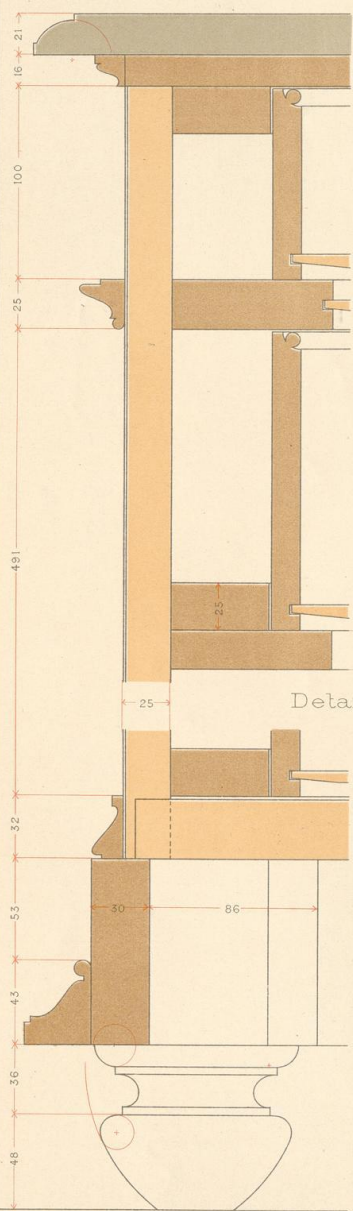

Schnitt ab.

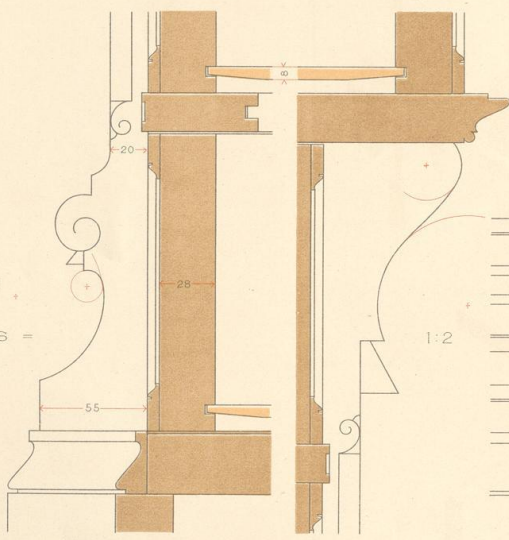
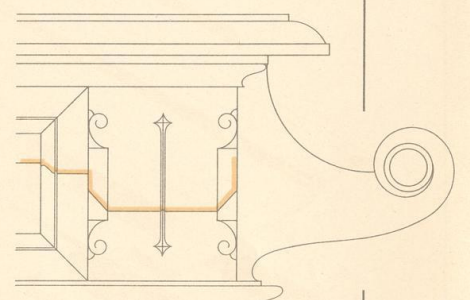

Details =

1:2

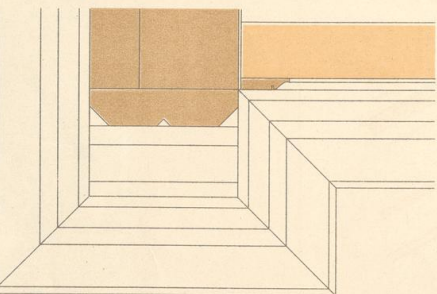

Wohnort und Datum.

Namen.

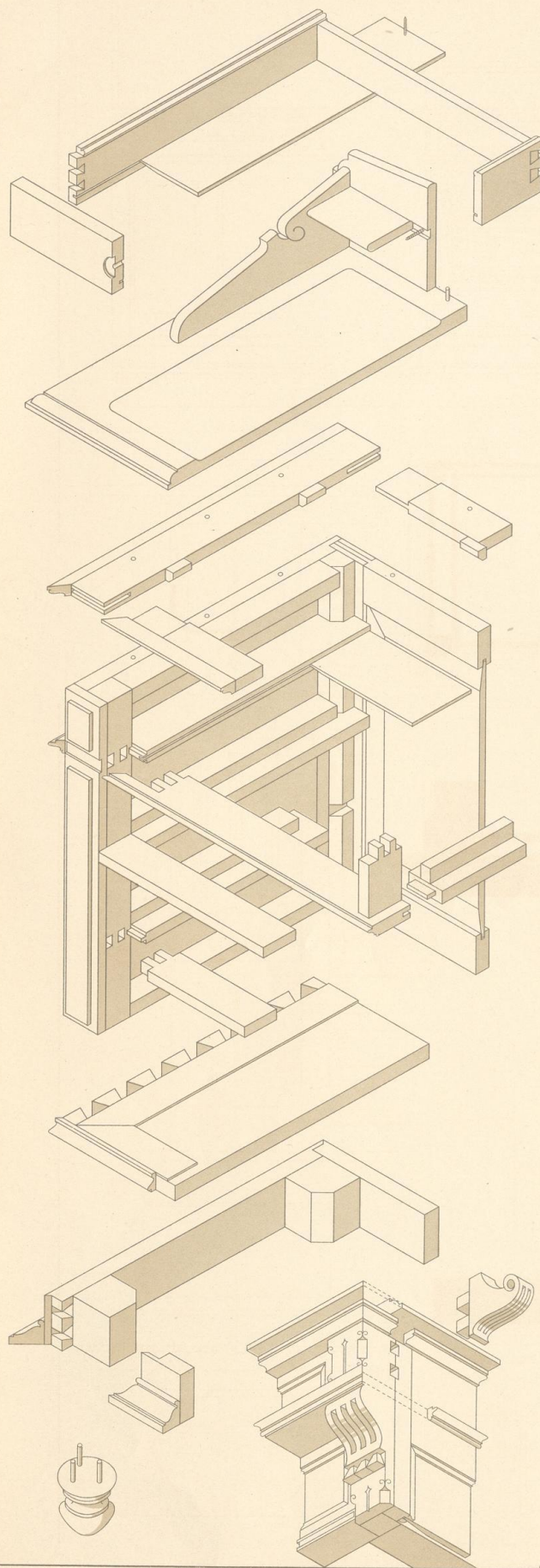



06
WTG
1199

EK 938
K D / XV

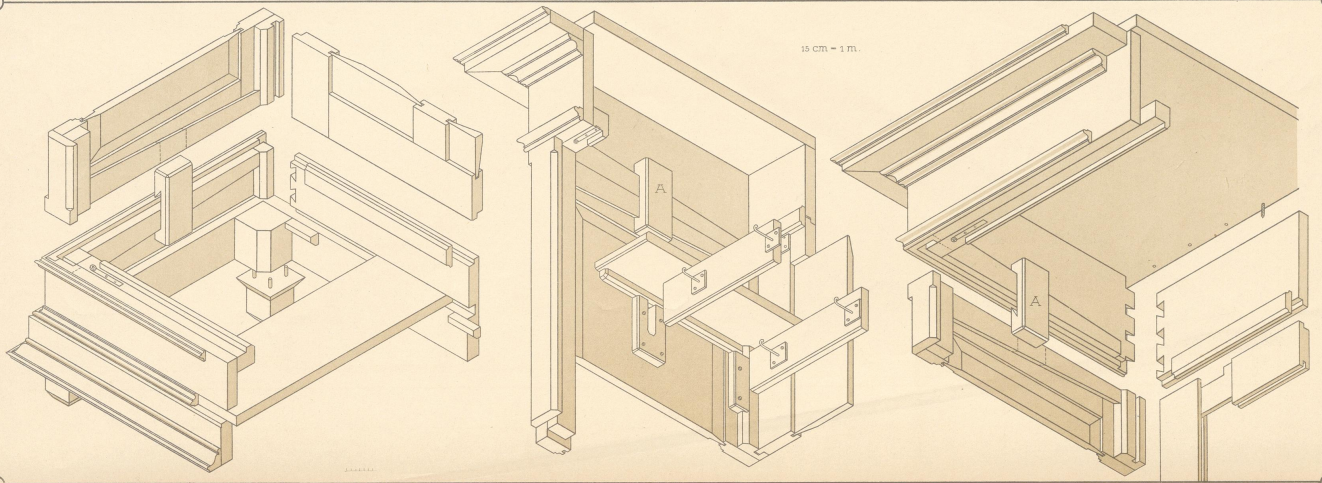

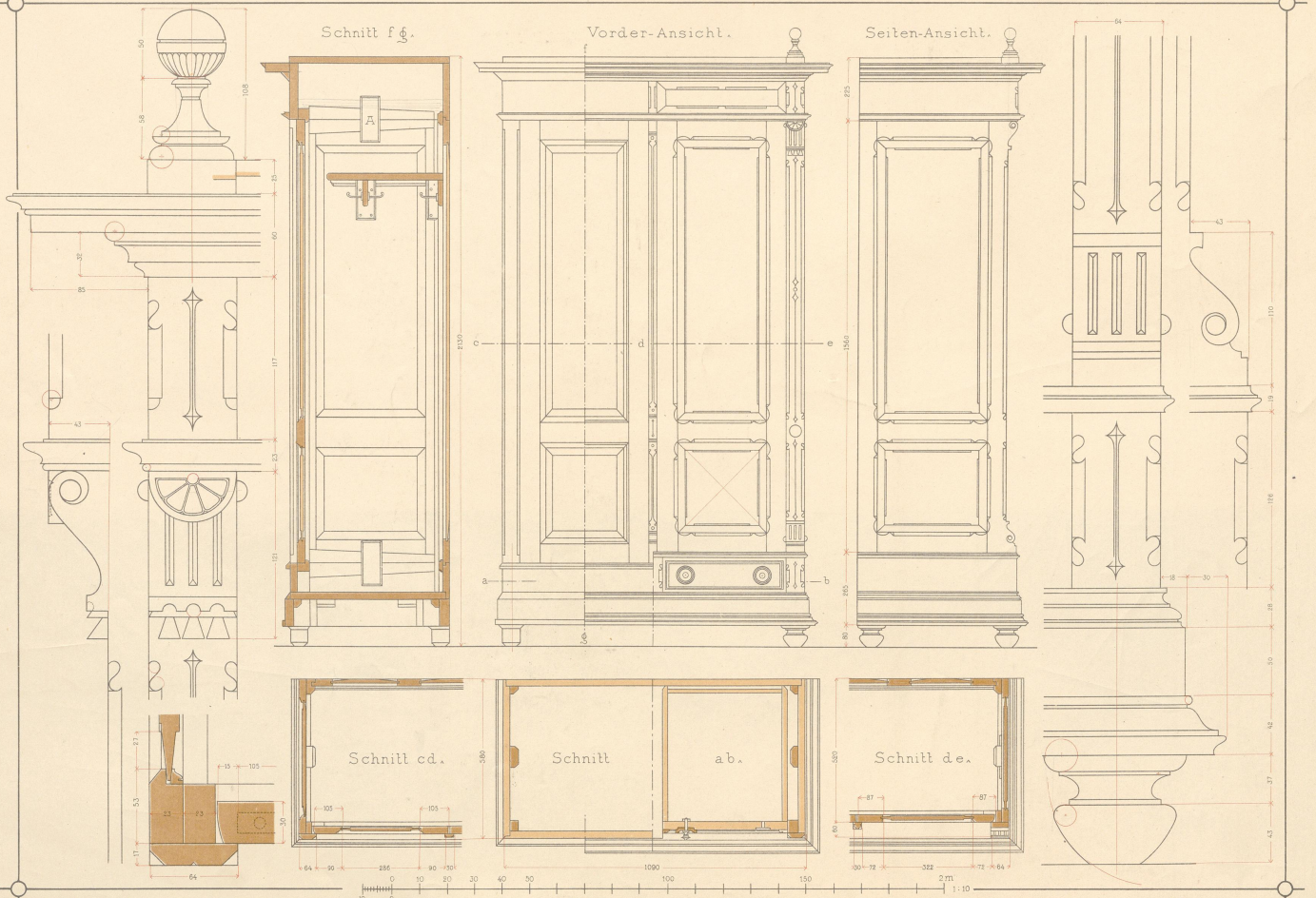

Wohnort und Datum.

Namen.

06
WTC
1/199



EK938
K 0/11