



UNIVERSITÄTS-  
BIBLIOTHEK  
PADERBORN

**Vorlagen für den gewerblichen Fachunterricht an  
technischen Lehranstalten insbesondere an  
Gewerbeschulen**

**Kircher, Philipp**

**Karlsruhe, [1886 - 1889]**

2. Einfaches Schloss.

---

[urn:nbn:de:hbz:466:1-97992](https://nbn-resolving.org/urn:nbn:de:hbz:466:1-97992)

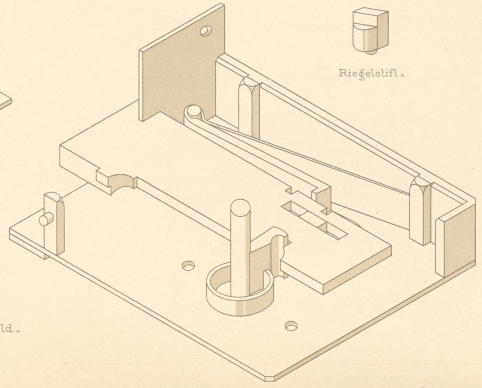
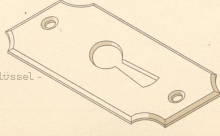
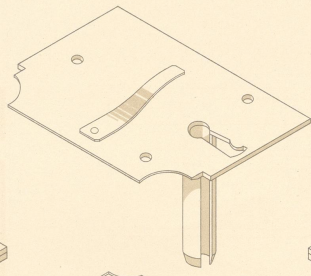
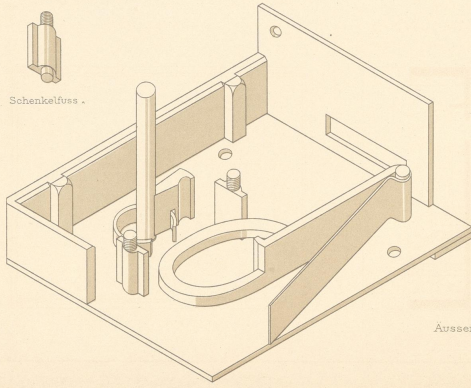
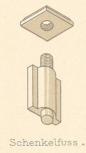

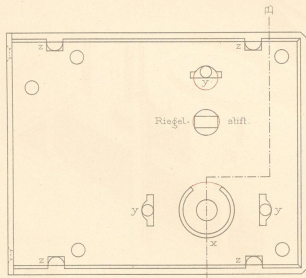

Schlosskasten.

yy - Schenkelfüsse, zz - Umschweifstiften.

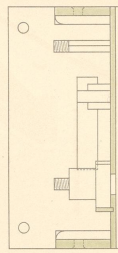

Schnitt A.B.

Riegel Schloss für Keller und Speicher.  
(eintourig).

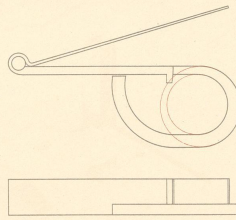

Zuhaltung.

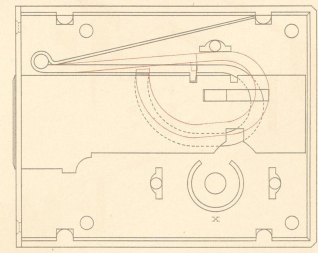

Schlosskasten mit Riegel und Zuhaltung.

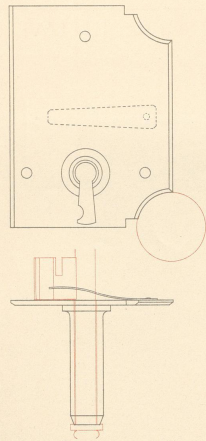

Schlossdecke mit Schlüsselrohr und Schleppfeder.

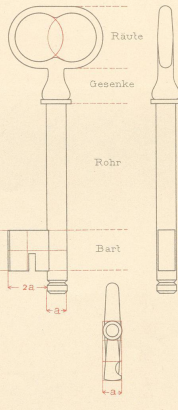

Schlüssel.  
(zum Reifchen x 1).

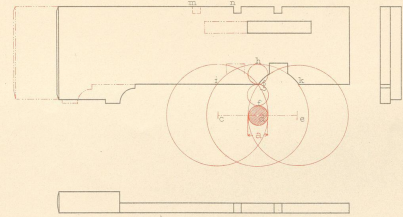
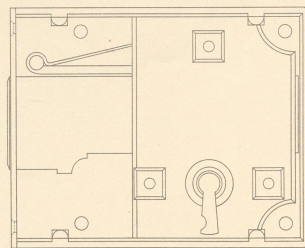
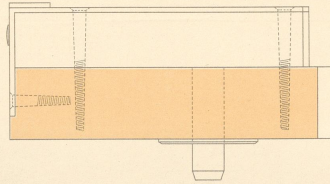

Schliessriegel.

fh - gi - de - mn - Schlüssellänge.  
Schlüssellänge - Barthöhe.  
Barthöhe - Bartbreite.  
1/2 Bartbreite - 1/2 Barthöhe - Rohrdicke a.

Wohnort und Datum.

Namen.



EK 938  
K D / XI



06  
076  
M199